



# Wireless Dimmer Remote

## EA2024-01 Wireless Dimmer

To be used with: T5, T8, T9 and Extendlite products.

### ACCESSORIES AND DESIGN:

1. Remote Receiver

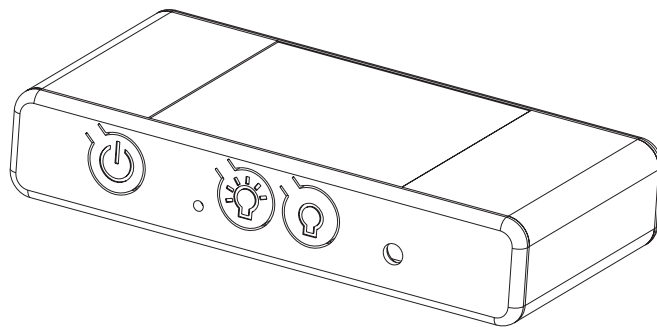

2. Wireless Remote Controller

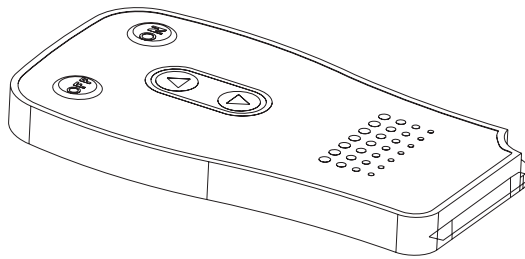

3. Connecting Wires

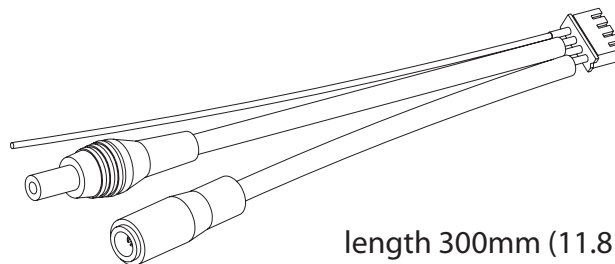

length 300mm (11.81")



# Wireless Dimmer Remote

## FUNCTION AND DIMENSION:

Front of the Remote Receiver

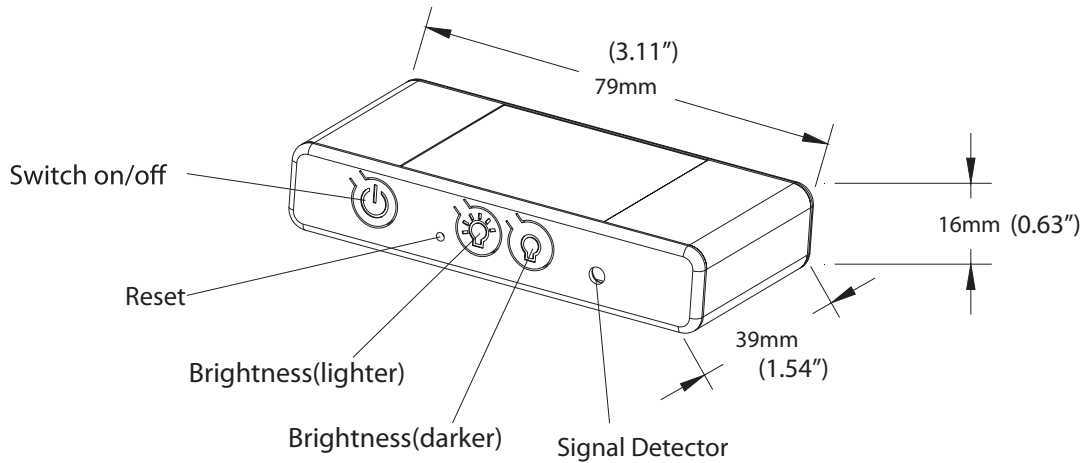

Wireless Remote Controller

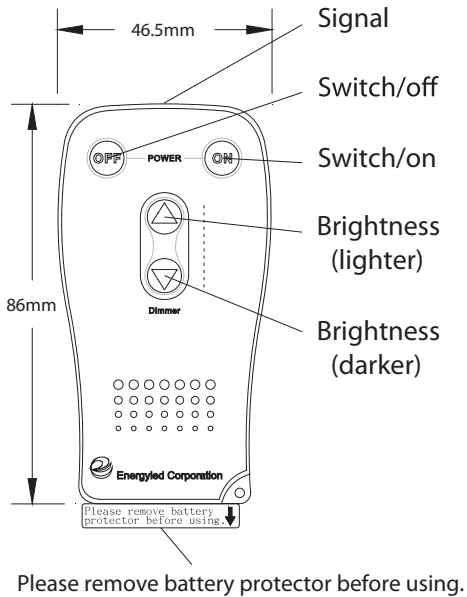

Back of the Remote Receiver

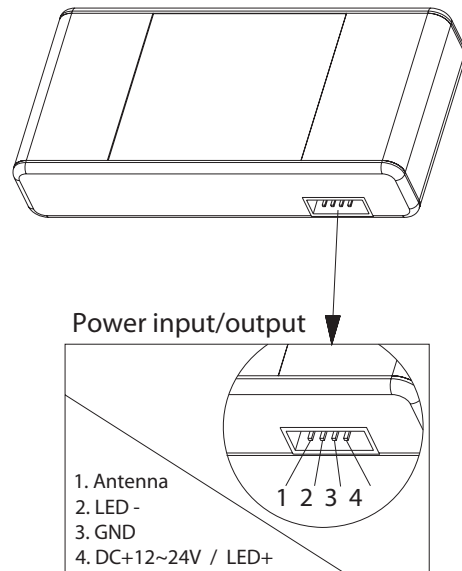



# Wireless Dimmer Remote

## CONNECTION GUIDE:

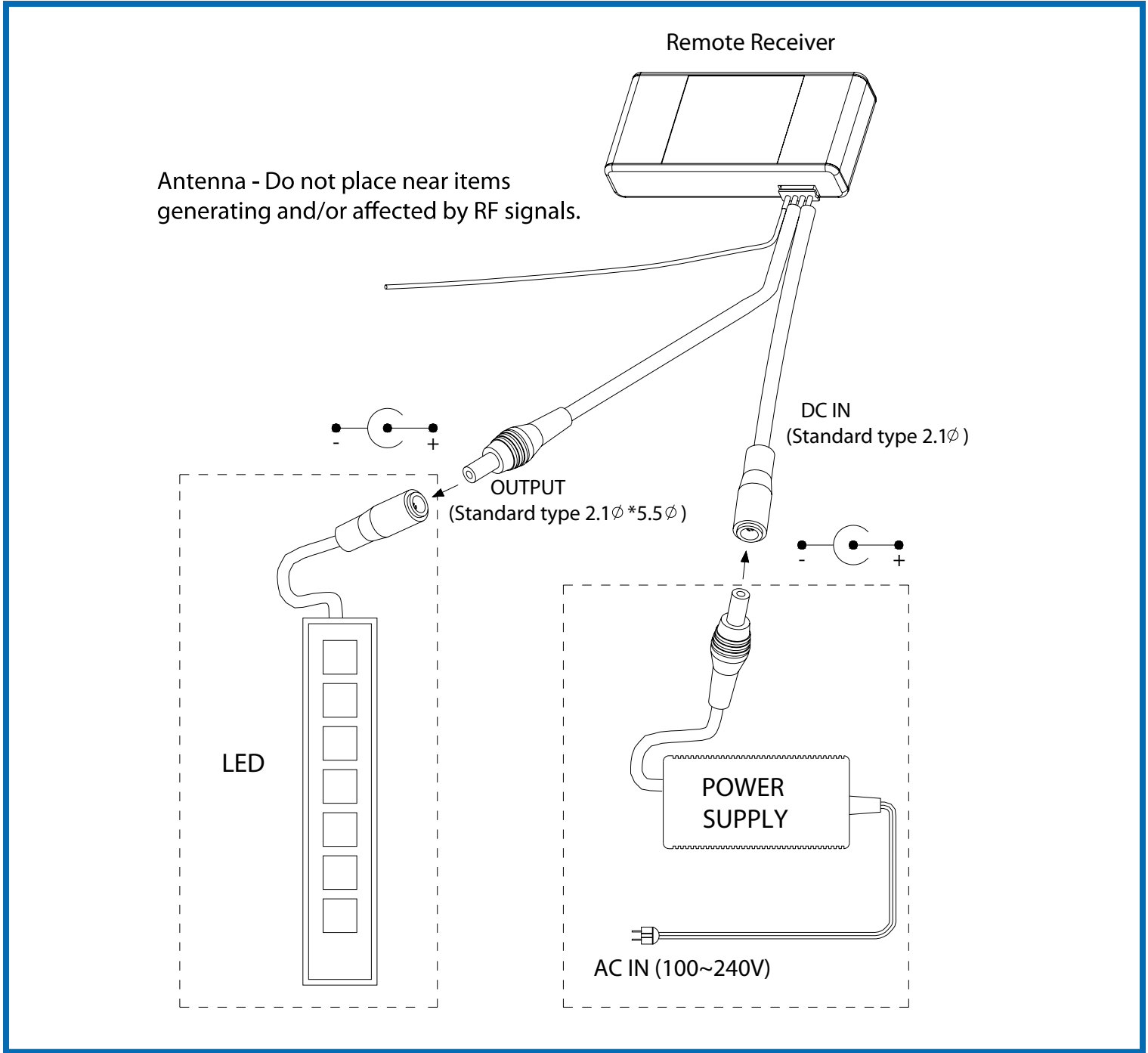



# Wireless Dimmer Remote

## REMOTE RECEIVER:

Article	Specification
Input Voltage	DC12V ~24V(max)
Output Voltage	DC12V ~24V(max)
Await Power-Consuming	19mA(max)
Output Current	0 ~ 3A
Output Power	36W (12V) 72W (24V)
Brightness Adjustment %	5% ~ 100%
Receiving Distance	15m (49.21')
Operating Temperature	10°C ~ 40°C
Storage Temperature	-40°C ~ 85°C
Dimensions	79mm (L) x 39mm (W) x 16mm (H) 3.11" (L) x 1.54" (W) x 0.30" (H)

## REMOTE CONTROLLER:

Article	Specification
Controller Angle	No Limitation
Dimensions	79mm (L) x 39mm (W) x 16mm (H) 3.11" (L) x 1.54" (W) x 0.30" (H)
Suggested Battery	CR2025 (3V) Lithium Battery (Included)